

8 7 6 5 4 3 2 1

THE INFORMATION CONTAINED IN THIS DRAWING IS THE SOLE PROPERTY OF INTELLECT. ANY REPRODUCTION IN PART OR WHOLE WITHOUT THE WRITTEN PERMISSION OF INTELLECT IS PROHIBITED.

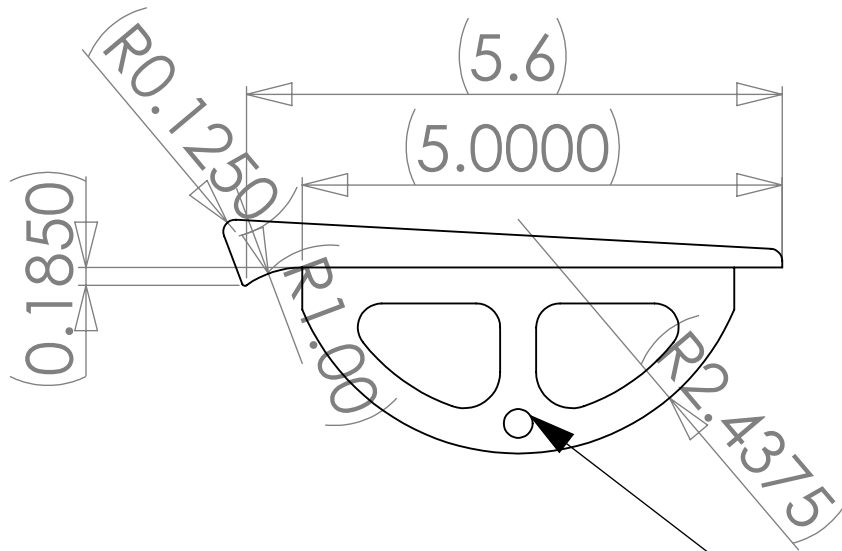

Optional Locking Pin

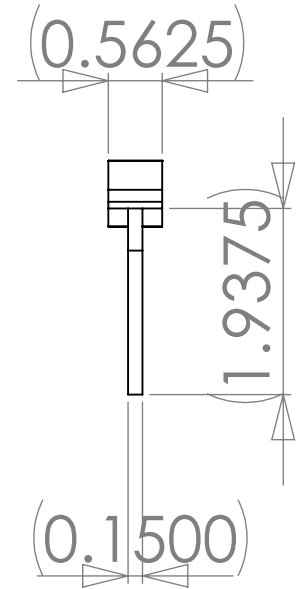

Cast 316 Stainless Steel with Brush Finish.

Use locking pin option for grout joint installations.

Spacing: 18-24" from corner to first/last piece and approx 30-48" on center for symmetry.

INTELLECT
SAN DIEGO, CALIFORNIA, U.S.A.

DR10-6

SIZE A	DWG. NO.	REV.
SCALE	CAD FILE:	SHEET OF
	2	1